

2" (50 mm) exit compression driver for high sensitivity, low distortion and smooth extended frequency response applications. Its pure titanium diaphragm was especially designed based on the extremely light and structurally strong snowflake crystal. That leads the D408Ti driver to deliver high performance, high quality and high value for the pinnacle in sound reinforcement applications.

It combines a stable structure for mid-frequency reproduction and a low mass that enables high frequency reproduction virtually linear to 20 kHz.

Its construction features include:

- ferrofluid (Ferrosound®) loaded gap reducing heat build-up and offering consistent results over long-term demanding concert usage;
- voice coil is made of high temperature CCAW (copper clad aluminium wire) wound on Kapton® former to withstand high operating temperatures;
- injected plastic housing;
- precisely engineered diaphragm structure and alignment mechanism allows for easy, reliable and cost effective repair (model RPD4400Ti) in case of diaphragm failure.



SPECIFICATIONS

Nominal impedance	8
Minimum impedance @ 3,450 Hz	6.3
Power handling	
Musical Program(w/ xover 800 Hz 12 dB / oct) ¹	200 W
Musical Program(w/ xover 1,200 Hz 12 dB / oct) ¹	250 W
Sensitivity	
On horn, 2.83V @ 1m, on axis ²	111 dB SPL
On plane-wave tube, 0.0894V ³	113 dB SPL
Frequency response @ -10 dB	400 to 20,000 Hz
Throat diameter	50 (2) mm (in)
Diaphragm material	Titanium
Voice coil diameter	100 (4) mm (in)
Re	4.8
Flux density	1.70 T
Minimum recommended crossover (12 dB / oct)	800 Hz

¹ Power handling specifications refer to normal speech and/or music program material, reproduced by an amplifier producing no more than 5% distortion. Power is calculated as true RMS voltage squared divided by the nominal impedance of the loudspeaker. This voltage is measured at the input of the recommended passive crossover when placed between the power amplifier and loudspeaker.
Musical Program= 2 x W RMS.

² Measured with HL4750-SLF horn, 800 - 6,000 Hz average.

³ The sensitivity represents the SPL in a 25 mm terminated tube, 400 - 3,000 Hz average.

ADDITIONAL INFORMATION

Magnet material	Barium ferrite
Magnet weight	2,640 (92) g (oz)
Magnet diameter x depth	200 x 24 (7.87 x 0.95) mm (in)
Magnetic assembly weight	7,860 (17.32) g (lb)
Housing material	Plastic
Housing finish	Gray
Magnetic assembly steel finish	Zinc-plated
Voice coil material	CCA W
Voice coil former material	Polyimide (Kapton®)
Voice coil winding length	6.0 (19.7) m (ft)
Voice coil winding depth	2.0 (0.08) mm (in)
Wire temperature coefficient of resistance ()	0.00404 1/°C
Volume displaced by driver	2.2 (0.078) l (ft³)
Net weight	8,540 (18.83) g (lb)
Gross weight	8,720 (19.22) g (lb)
Carton dimensions (W x D x H)	23 x 23 x 10 (9.1 x 9.1 x 3.9) cm (in)

MOUNTING INFORMATION

Horn connection	Bolt on
Number of holes	4 (M6) equally spaced threaded holes
Threaded holes diameter	102 (4) mm (in)
Connectors	Push terminals
Polarity	Positive voltage applied to the positive terminal (red) gives diaphragm motion toward the throat

DRIVER x HORN CONNECTION

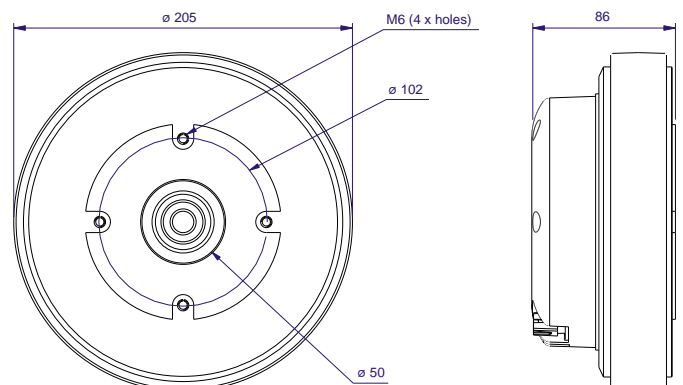
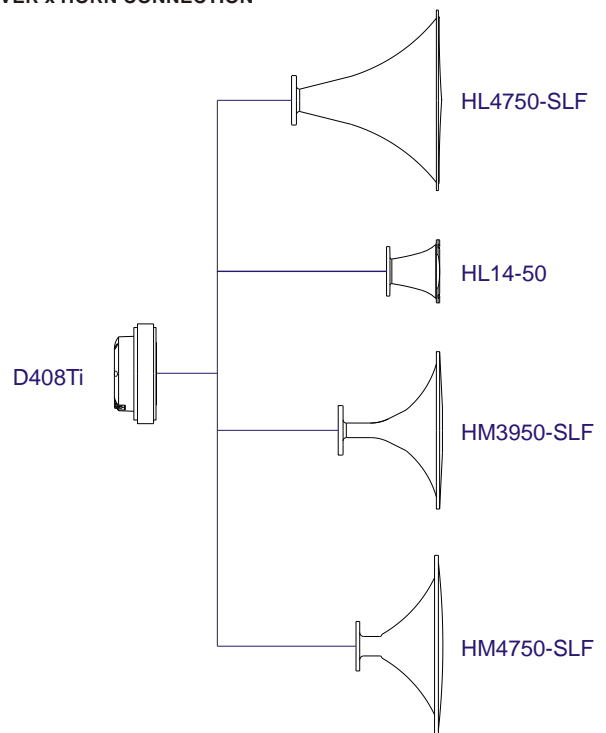

Dimensions in mm.

RESPONSE AND IMPEDANCE CURVES W/ HL4750-SLF HORN INSIDE AN ANECHOIC CHAMBER, 1 W / 1 m

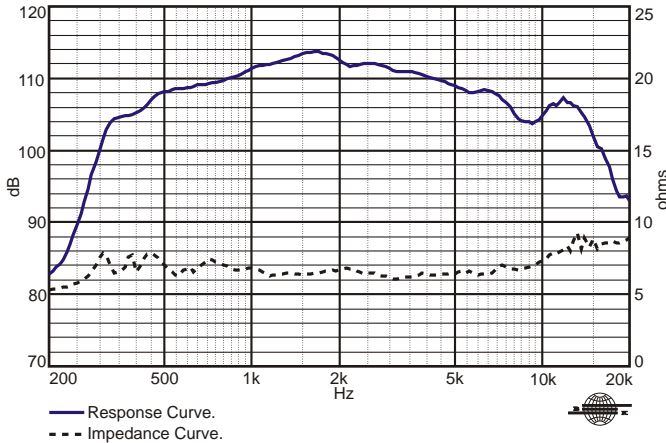

HARMONIC DISTORTION CURVES W/ HL4750-SLF HORN, 10 W / 1 m.

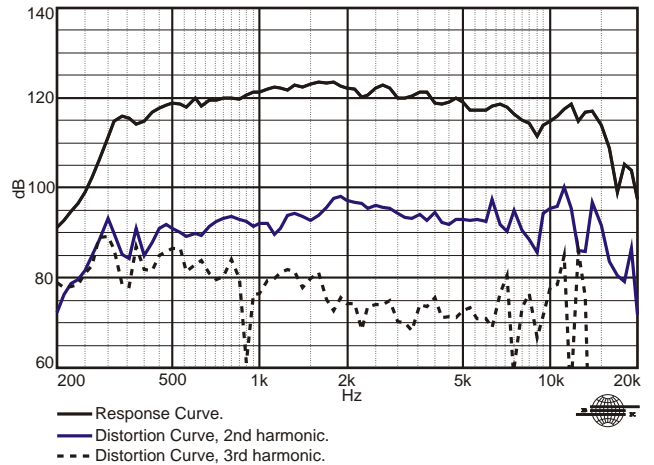

RESPONSE AND IMPEDANCE CURVES W/ PLANE-WAVE TUBE, 1 mW

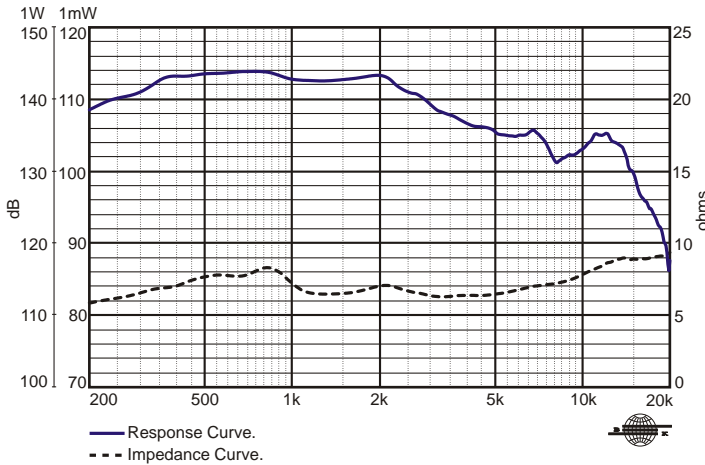

Frequency response and impedance curves measured with 50 mm terminated plane-wave tube, with sensitivity referenced to a 25 mm tube.

POLAR RESPONSE CURVES

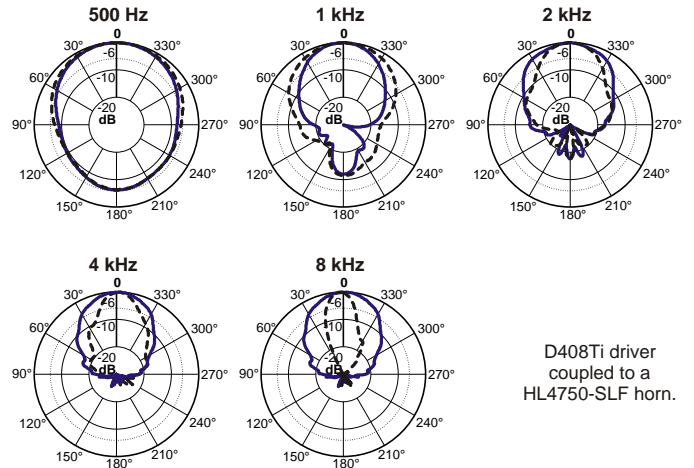

D408Ti driver coupled to a HL4750-SLF horn.

— Polar Response Curve, Horizontal.
- - - Polar Response Curve, Vertical.

HARMONIC DISTORTION CURVES W/ HL4750-SLF HORN, 1 W / 1 m.

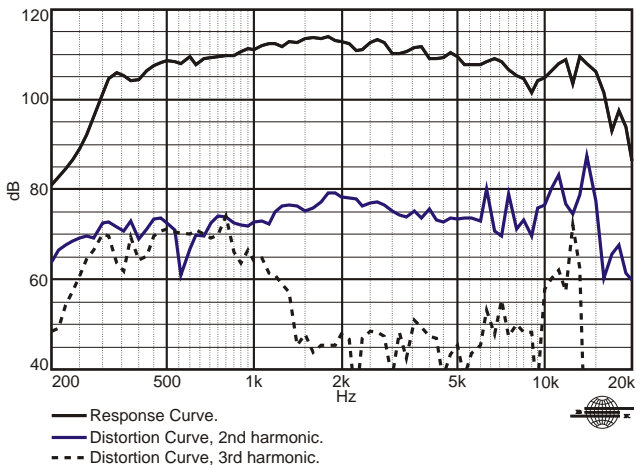

HOW TO CHOOSE THE RIGHT AMPLIFIER

The power amplifier must be able to supply twice the RMS driver power. This 3 dB headroom is necessary to handle the peaks that are common to musical programs. When the amplifier clips those peaks, high distortion arises and this may damage the transducer due to excessive heat. The use of compressors is a good practice to reduce music dynamics to safe levels.

FINDING VOICE COIL TEMPERATURE

It is very important to avoid maximum voice coil temperature. Since moving coil resistance (R_c) varies with temperature according to a well known law, we can calculate the temperature inside the voice coil by measuring the voice coil DC resistance:

$$T_B = T_A \frac{R_B}{R_A} - 1 \quad T_A = 25 \quad \frac{1}{25}$$

T_A, T_B = voice coil temperatures in °C.

R_A, R_B = voice coil resistances at temperatures T_A and T_B , respectively.

= voice coil wire temperature coefficient at 25 °C.

Kapton®: Du Pont trademark.

Ferrosound®: Ferrofluidics Corporation trademark.